

### GENERAL SPECIFICATIONS FOR S301 ~ S339

Toggles  
A

Rockers

Pushbuttons

Illuminated PB

Programmable

Keylocks

Rotaries

Slides

Tactiles

Tilt

Touch

Indicators

Accessories

Supplement

### Electrical Capacity (Resistive & Inductive Load)

**Power Level:** Shown in the following tables

### Other Ratings

|  |  |
|--|--|
| <b>Contact Resistance:</b>                   | 10 milliohms maximum   |
| <b>Insulation Resistance:</b>                | 1,000 megohms minimum @ 500V DC  |
| <b>Dielectric Strength:</b>                  | 2,000V AC minimum for 1 minute minimum   |
| <b>Mechanical Life:</b>                      | 50,000 operations minimum  |
| <b>Electrical Life:</b>                      | 6,000 operations minimum for S331F; 15,000 operations minimum for all other S331s;<br>25,000 operations minimum for all others |
| <b>Angle of Throw (<math>\alpha</math>):</b> | Shown on following tables  |

### Materials & Finishes

|   |   |
|---|---|
| <b>Toggle:</b>                            | PBT for flatted lever; brass with chrome plating for all others |
| <b>Bushing:</b>                           | Brass with chrome plating                                       |
| <b>Case:</b>                              | Melamine phenol   |
| <b>Case Cover:</b>                        | Steel with zinc plating   |
| <b>Movable Contactor:</b>                 | Copper with silver plating                                      |
| <b>Movable &amp; Stationary Contacts:</b> | Silver alloy capped on copper with silver plating               |
| <b>Terminals:</b>                         | Brass with tin plating  |

### Environmental Data

**Operating Temperature Range:**  $-10^{\circ}\text{C} \sim +70^{\circ}\text{C}$  ( $+14^{\circ}\text{F} \sim +158^{\circ}\text{F}$ )

### Installation

**Mounting Torque:** 2.94Nm (26 lb•in) for double nut; 1.47Nm (13 lb•in) for single nut  
**Soldering Time & Temperature:** Manual Soldering: See Profile A in Supplement section.

### Standards & Certifications

- UL:** File No. E44145 - Recognized only when ordered with marking on switch. Add "/U" or "/CUL" to end of part number to order UL recognized switch. UL or cULus recognition designated beside part numbers on following pages. See Supplement section to find UL or cULus rating details.
- CSA:** File No. 023535\_0\_000 - Certified only when ordered with marking on switch. Add "/C" to end of part number to order CSA certified switch. CSA certification designated beside part numbers on following pages. See Supplement section to find CSA rating details.

## SINGLE POLE WITH SOLDER LUG \*

| * UL, cULus & CSA recognized only when ordered with marking on switch (see General Specs) |             |       | Toggle Position/Connected Terminals<br>( ) = Momentary |              |                |        |          |           | Electrical Capacity |        |                                |                |
|---|-------------|-------|--|--------------|----------------|--------|----------|-----------|---------------------|--------|--------------------------------|----------------|
| Model   | * Approvals |       |  | Pole & Throw | Down<br>Keyway | Center | Up       | Resistive |                     |        | Inductive<br>AC 125V<br>PF 0.6 | Angle of Throw |
|   | UL          | cULus | CSA  |              |                |        |          | AC 125V   | AC 250V             | DC 30V |                                |                |
| S301  | ✓           | ✓     | ✓  | SPST         | ON 1-3         | NONE   | OFF —    | 15A       | 6A                  | 20A    | 10A                            | 32°            |
| S302  | ✓           | ✓     | ✓  | SPDT         | ON 2-3         | NONE   | ON 2-1   | 15A       | 6A                  | 20A    | 10A                            | 32°            |
| S303  | ✓           | ✓     | ✓  | SPDT         | ON 2-3         | OFF    | ON 2-1   | 15A       | 6A                  | 20A    | 10A                            | 32°            |
| S305  | —           | —     | ✓  | SPDT         | ON 2-3         | NONE   | (ON) 2-1 | 15A       | 6A                  | 20A    | 8A                             | 32°            |
| S308  | —           | —     | ✓  | SPDT         | (ON) 2-3       | OFF    | (ON) 2-1 | 15A       | 6A                  | 20A    | 8A                             | 32°            |
| S309  | —           | —     | ✓  | SPDT         | ON 2-3         | OFF    | (ON) 2-1 | 15A       | 6A                  | 20A    | 8A                             | 32°            |

**Throw & Schematics:** SPST INTERNAL CONNECTION Note: Terminal numbers are actually on the switch

**Notes:** Standard Hardware: AT503M Face Hex Nut, AT506M Locking Ring, AT508 Lockwasher, AT527M Backup Hex Nut. See Accessories & Hardware section. Optional Splashproof Boot Assemblies: AT401 & AT4181 boots plus hex nut & o-ring. See Accessories & Hardware section.

\* Wire harness & cable assemblies offered only in Americas.



## DOUBLE POLE WITH SOLDER LUG \*

| * UL, cULus & CSA recognized only when ordered with marking on switch (see General Specs) |             |       | Toggle Position/Connected Terminals<br>( ) = Momentary |              |                |        |              |           | Electrical Capacity |        |                                |                           |
|---|-------------|-------|--|--------------|----------------|--------|--------------|-----------|---------------------|--------|--------------------------------|---------------------------|
| Model   | * Approvals |       |  | Pole & Throw | Down<br>Keyway | Center | Up           | Resistive |                     |        | Inductive<br>AC 125V<br>PF 0.6 | $\alpha$ = Angle of Throw |
|   | UL          | cULus | CSA  |              |                |        |              | AC 125V   | AC 250V             | DC 30V |                                |                           |
| S331  | ✓           | ✓     | ✓  | DPST         | ON 1-3 4-6     | NONE   | OFF —        | 25A       | 25A                 | 25A    | 10A                            | 25°                       |
| S332  | ✓           | ✓     | ✓  | DPDT         | ON 2-3 5-6     | NONE   | ON 2-1 5-4   | 25A       | 15A                 | 25A    | 10A                            | 25°                       |
| S333  | ✓           | ✓     | ✓  | DPDT         | ON 2-3 5-6     | OFF    | ON 2-1 5-4   | 25A       | 15A                 | 25A    | 10A                            | 30°                       |
| S335  | ✓           | ✓     | ✓  | DPDT         | ON 2-3 5-6     | NONE   | (ON) 2-1 5-4 | 15A       | 6A                  | 20A    | 8A                             | 25°                       |
| S338  | ✓           | ✓     | —  | DPDT         | (ON) 2-3 5-6   | OFF    | (ON) 2-1 5-4 | 15A       | 6A                  | 20A    | 8A                             | 25°                       |
| S339  | ✓           | ✓     | —  | DPDT         | ON 2-3 5-6     | OFF    | (ON) 2-1 5-4 | 15A       | 6A                  | 20A    | 8A                             | 25°                       |

**Throw & Schematics:** DPST INTERNAL CONNECTION Note: Terminal numbers are actually on the switch

**Notes:** Standard Hardware: AT503M Face Hex Nut, AT506M Locking Ring, AT508 Lockwasher, AT527M Backup Hex Nut. See Accessories & Hardware section. Optional Splashproof Boot Assemblies: AT401 & AT4181 boots plus hex nut & o-ring. See Accessories & Hardware section.

\* Wire harness & cable assemblies offered only in Americas.



### DOUBLE POLE WITH SOLDER LUG & FLATTED LEVER \*

| Model | * Approvals |       |    | Pole & Throw | Toggle Position/Connected Terminals<br>( ) = Momentary                                    |   |   |           |         |        | Electrical Capacity |                           |  |  |
|-------|-------------|-------|----|--------------|---|---|---|-----------|---------|--------|---------------------|---------------------------|--|--|
|       | UL          | cULus | CS |              | Down<br> | Center<br> | Up<br> | Resistive |         |        | Inductive           | $\alpha$ = Angle of Throw |  |  |
|       |             |       |    |              |   |   |   | AC 125V   | AC 250V | DC 30V | AC 125V PF 0.6      |                           |  |  |
| S331R | ✓           | ✓     | —  | DPST         | ON 1-3 4-6  | NONE  | OFF —   | 25A       | 25A     | 25A    | 10A                 | 25°                       |  |  |
| S332R | ✓           | ✓     | —  | DPDT         | 2-3 5-6   | NONE  | ON 2-1 5-4  | 25A       | 15A     | 25A    | 10A                 | 25°                       |  |  |
| S333R | ✓           | ✓     | —  | DPDT         | ON 2-3 5-6  | OFF   | ON 2-1 5-4  | 25A       | 15A     | 25A    | 10A                 | 30°                       |  |  |
| S338R | ✓           | ✓     | —  | DPDT         | (ON) 2-3 5-6  | OFF   | (ON) 2-1 5-4  | 15A       | 6A      | 20A    | 8A                  | 25°                       |  |  |
| S339R | ✓           | ✓     | —  | DPDT         | ON 2-3 5-6  | OFF   | (ON) 2-1 5-4  | 15A       | 6A      | 20A    | 8A                  | 25°                       |  |  |



Note: Terminal numbers are actually on the switch

**Notes:** Standard Hardware: AT504M Knurled Nut, AT508 Lockwasher, AT527M Backup Hex Nut. See Accessories & Hardware section.

\* Wire harness & cable assemblies offered only in Americas.





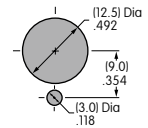
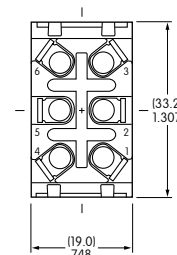
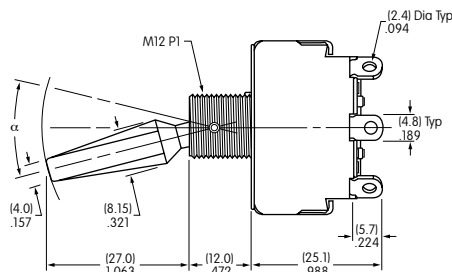
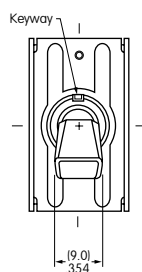



S331R



S331R does not have terminals 2 & 5

Maximum Panel Thickness: .220" (5.6mm)

## SINGLE POLE WITH SCREW LUG

| * UL, cULus & CSA recognized only when ordered with marking on switch (see General Specs) |   |   | Toggle Position/Connected Terminals<br>( ) = Momentary                            |              |   |   |   | Electrical Capacity |         |        |                | $\alpha$ = Angle of Throw |
|---|---|---|---|--------------|---|---|---|---------------------|---------|--------|----------------|---------------------------|
| Model   | * Approvals   |   |   | Pole & Throw | Down<br> | Center<br> | Up<br> | Resistive           |         |        | Inductive      |                           |
|   |  |  |  |              |   |   |   | AC 125V             | AC 250V | DC 30V | AC 125V PF 0.6 |                           |
| S301T   | ✓   | ✓   | ✓   | SPST         | ON 1-3  | NONE  | OFF —   | 15A                 | 6A      | 20A    | 10A            | 32°                       |
| S302T   | ✓   | ✓   | ✓   | SPDT         | ON 2-3  | NONE  | ON 2-1  | 15A                 | 6A      | 20A    | 10A            | 32°                       |
| S303T   | ✓   | ✓   | ✓   | SPDT         | ON 2-3  | OFF   | ON 2-1  | 15A                 | 6A      | 20A    | 10A            | 32°                       |
| S305T   | —   | —   | ✓   | SPDT         | ON 2-3  | NONE  | (ON) 2-1  | 15A                 | 6A      | 20A    | 8A             | 32°                       |
| S308T   | —   | —   | ✓   | SPDT         | (ON) 2-3  | OFF   | (ON) 2-1  | 15A                 | 6A      | 20A    | 8A             | 32°                       |
| S309T   | —   | —   | ✓   | SPDT         | ON 2-3  | OFF   | (ON) 2-1  | 15A                 | 6A      | 20A    | 8A             | 32°                       |

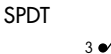
**Throw & Schematics:** SPST  INTERNAL CONNECTION  Note: Terminal numbers are actually on the switch

**Notes:** Standard Hardware: AT503M Face Hex Nut, AT506M Locking Ring, AT508 Lockwasher, AT527M Backup Hex Nut. See Accessories & Hardware section. Optional Splashproof Boot Assemblies: AT401 & AT4181 boots plus hex nut & o-ring. See Accessories & Hardware section.

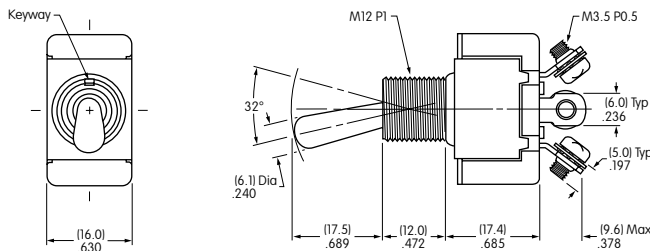

S301T does not have terminal 2

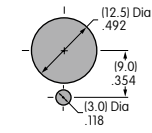

Maximum Panel Thickness: .185" (4.7mm)



**S301T**

## DOUBLE POLE WITH SCREW LUG

| * UL & cULus recognized only when ordered with marking on switch (see General Specs) |   |   | Toggle Position/Connected Terminals<br>( ) = Momentary                              |              |   |   |   | Electrical Capacity |         |        |                | $\alpha$ = Angle of Throw |
|--|---|---|---|--------------|---|---|---|---------------------|---------|--------|----------------|---------------------------|
| Model  | * Approvals   |   |   | Pole & Throw | Down<br> | Center<br> | Up<br> | Resistive           |         |        | Inductive      |                           |
|  |  |  |  |              |   |   |   | AC 125V             | AC 250V | DC 30V | AC 125V PF 0.6 |                           |
| S331T  | ✓   | ✓   | —   | DPST         | ON 1-3 4-6  | NONE  | OFF —   | 15A                 | 15A     | 15A    | 10A            | 25°                       |
| S332T  | ✓   | ✓   | —   | DPDT         | ON 2-3 5-6  | NONE  | ON 2-1 5-4  | 15A                 | 15A     | 15A    | 10A            | 25°                       |
| S333T  | ✓   | ✓   | —   | DPDT         | ON 2-3 5-6  | OFF   | ON 2-1 5-4  | 15A                 | 15A     | 15A    | 10A            | 30°                       |
| S335T  | ✓   | ✓   | —   | DPDT         | ON 2-3 5-6  | NONE  | (ON) 2-1 5-4  | 15A                 | 6A      | 20A    | 8A             | 25°                       |
| S338T  | ✓   | ✓   | —   | DPDT         | (ON) 2-3 5-6  | OFF   | (ON) 2-1 5-4  | 15A                 | 6A      | 20A    | 8A             | 25°                       |
| S339T  | ✓   | ✓   | —   | DPDT         | ON 2-3 5-6  | OFF   | (ON) 2-1 5-4  | 15A                 | 6A      | 20A    | 8A             | 25°                       |

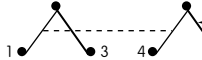
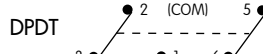
**Throw & Schematics:** DPST  INTERNAL CONNECTION  Note: Terminal numbers are actually on the switch

**Notes:** Standard Hardware: AT503M Face Hex Nut, AT506M Locking Ring, AT508 Lockwasher, AT527M Backup Hex Nut. See Accessories & Hardware section. Optional Splashproof Boot Assemblies: AT401 & AT4181 boots plus hex nut & o-ring. See Accessories & Hardware section.

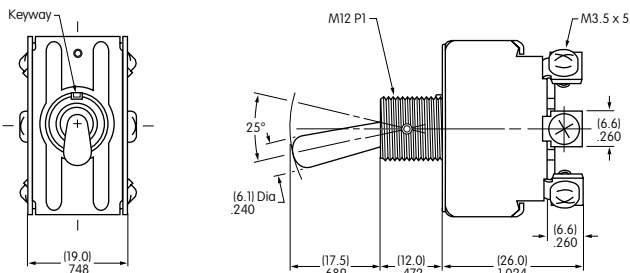

S331T does not have terminals 2 & 5

Maximum Panel Thickness: .185" (4.7mm)



**S331T**

Toggles  
A

### SINGLE POLE WITH QUICK CONNECT

| * UL, cULus & CSA recognized only when ordered with marking on switch (see General Specs) |             |       | Toggle Position/Connected Terminals |              |        |        | Electrical Capacity |           |         |        | α = Angle of Throw |                |
|---|-------------|-------|-------------------------------------|--------------|--------|--------|---------------------|-----------|---------|--------|--------------------|----------------|
| Model   | * Approvals |       |                                     | Pole & Throw | Down   | Center | Up                  | Resistive |         |        |                    | Inductive      |
|   | UL          | cULus | CSA                                 |              | Keyway |        |                     | AC 125V   | AC 250V | DC 30V |                    | AC 125V PF 0.6 |
| S301F   | ✓           | ✓     | ✓                                   | SPST         | ON 1-3 | NONE   | OFF —               | 15A       | 6A      | 20A    | 10A                | 32°            |

**Throw & Schematics:** SPST  INTERNAL CONNECTION

**Note:** Terminal numbers are actually on the switch

**Notes:** Standard Hardware: AT503M Face Hex Nut, AT506M Locking Ring, AT508 Lockwasher, AT527M Backup Hex Nut. See Accessories & Hardware section. Optional Splashproof Boot Assemblies: AT401 & AT4181 boots plus hex nut & o-ring. See Accessories & Hardware section.



S301F

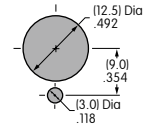
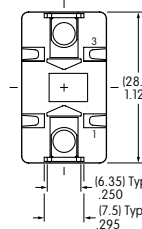
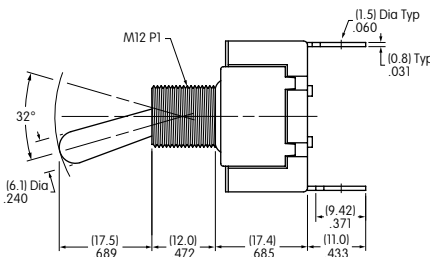
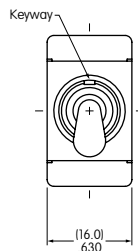

Maximum Panel Thickness: .185" (4.7mm)

Rockers

Pushbuttons

Illuminated PB

Programmable

Keylocks

Rotaries

### DOUBLE POLE WITH QUICK CONNECT

| * UL & cULus recognized only when ordered with marking on switch (see General Specs) |             |       | Toggle Position/Connected Terminals ( ) = Momentary |              |            |        | Electrical Capacity |           |         |        | α = Angle of Throw |                |
|--|-------------|-------|---|--------------|------------|--------|---------------------|-----------|---------|--------|--------------------|----------------|
| Model  | * Approvals |       |   | Pole & Throw | Down       | Center | Up                  | Resistive |         |        |                    | Inductive      |
|  | UL          | cULus | CSA   |              | Keyway     |        |                     | AC 125V   | AC 250V | DC 30V |                    | AC 125V PF 0.6 |
| S331F  | ✓           | ✓     | —   | DPST         | ON 1-3 4-6 | NONE   | OFF —               | 25A       | 25A     | 25A    | 10A                | 25°            |
| S332F  | ✓           | ✓     | —   | DPDT         | ON 2-3 5-6 | NONE   | ON 2-1 5-4          | 25A       | 15A     | 25A    | 10A                | 25°            |
| S333F  | ✓           | ✓     | —   | DPDT         | ON 2-3 5-6 | OFF    | ON 2-1 5-4          | 25A       | 15A     | 25A    | 10A                | 30°            |
| S335F  | ✓           | ✓     | —   | DPDT         | ON 2-3 5-6 | NONE   | (ON) 2-1 5-4        | 15A       | 6A      | 20A    | 8A                 | 25°            |

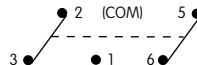
**Throw & Schematics:** DPST  INTERNAL CONNECTION DPDT 

**Note:** Terminal numbers are actually on the switch

**Notes:** Standard Hardware: AT503M Face Hex Nut, AT506M Locking Ring, AT508 Lockwasher, AT527M Backup Hex Nut. See Accessories & Hardware section. Optional Splashproof Boot Assemblies: AT401 & AT4181 boots plus hex nut & o-ring. See Accessories & Hardware section.



S332F

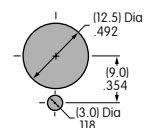
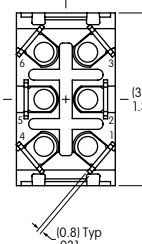
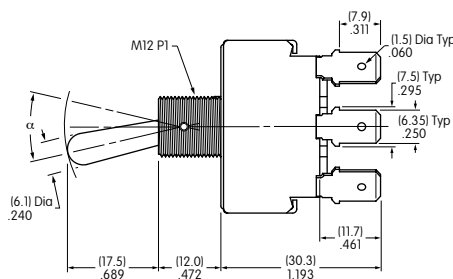
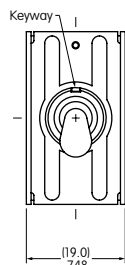

Maximum Panel Thickness: .185" (4.7mm)

S331F does not have terminals 2 & 5

Touch

Indicators

Accessories

Supplement

## GENERAL SPECIFICATIONS FOR S31 ~ S49

### Electrical Capacity (Resistive & Inductive Load)

**Power Level:** Shown in the following tables

### Other Ratings

**Contact Resistance:** 10 milliohms maximum  
**Insulation Resistance:** 1,000 megohms minimum @ 500V DC  
**Dielectric Strength:** 2,000V AC minimum for 1 minute minimum  
**Mechanical Life:** 50,000 operations minimum  
**Electrical Life:** 25,000 operations minimum  
**Angle of Throw ( $\alpha$ ):** Shown on following tables

### Materials & Finishes

**Toggle:** PBT resin for flatted lever; brass with chrome plating for all others  
**Bushing:** Brass with chrome plating  
**Case:** Phenolic resin  
**Case Cover:** Steel with chromate plating over zinc plating  
**Movable Contact:** Copper with silver plating  
**Movable Contacts:** Silver alloy capped on copper with silver plating  
**Stationary Contacts:** Silver alloy capped on copper with silver plating  
**Terminals:** Brass with tin plating

### Environmental Data

**Operating Temp Range:** -10°C through +70°C (+14°F through +158°F)

### Installation

**Mounting Torque:** 2.94Nm (26 lb•in) for double nut  
**Maximum Panel Thickness:** Shown beneath panel cutout in switch dimension drawings  
**Soldering Time & Temperature:** Manual Soldering: See Profile A in Supplement section.

### Standards & Certifications

**UL:** File No. E44145 - Recognized only when ordered with marking on switch.  
 Add "/U" or "/CUL" to end of part number to order UL recognized switch.  
 UL or cULus recognition designated beside part numbers on following pages.  
 See Supplement section to find UL or cULus rating details.

**CSA:** File No. 023535\_0\_000 - Certified only when ordered with marking on switch.  
 Add "/C" to end of part number to order CSA certified switch.  
 CSA certification designated beside part numbers on following pages.  
 See Supplement section to find CSA rating details.

A  
Toggles

Rockers

Pushbuttons

Illuminated PB

Programmable

Keylocks

Rotaries

Slides

Tactiles

Tilt

Touch

Indicators

Accessories

Supplement

Toggles **A**

### THREE POLE WITH SOLDER LUG \*

| Model | * Approvals |       |     | Pole & Throw | Toggle Position/Connected Terminals<br>( ) = Momentary |             |      |           |             |        | Electrical Capacity            |     |     |     | $\alpha$ = Angle of Throw |
|-------|-------------|-------|-----|--------------|--|-------------|------|-----------|-------------|--------|--------------------------------|-----|-----|-----|---------------------------|
|       | UL          | cULus | CSA |              | Down<br>Keyway   | Center      | Up   | Resistive |             |        | Inductive<br>AC 125V<br>PF 0.6 |     |     |     |                           |
|       |             |       |     |              |  |             |      | AC 125V   | AC 250V     | DC 30V |                                |     |     |     |                           |
| S31   | ✓           | ✓     | ✓   | 3PST         | ON   | 1-3 4-6 7-9 | NONE | OFF       | —           | 25A    | 9A                             | 20A | 10A | 25° |                           |
| S32   | ✓           | ✓     | ✓   | 3PDT         | ON   | 2-3 5-6 8-9 | NONE | ON        | 2-1 5-4 8-7 | 25A    | 9A                             | 20A | 10A | 25° |                           |
| S33   | ✓           | ✓     | ✓   | 3PDT         | ON   | 2-3 5-6 8-9 | OFF  | ON        | 2-1 5-4 8-7 | 25A    | 9A                             | 20A | 10A | 30° |                           |
| S35   | ✓           | ✓     | ✓   | 3PDT         | ON   | 2-3 5-6 8-9 | NONE | (ON)      | 2-1 5-4 8-7 | 15A    | 6A                             | 20A | 8A  | 25° |                           |
| S38   | ✓           | ✓     | ✓   | 3PDT         | (ON)   | 2-3 5-6 8-9 | OFF  | (ON)      | 2-1 5-4 8-7 | 15A    | 6A                             | 15A | 8A  | 25° |                           |
| S39   | ✓           | ✓     | ✓   | 3PDT         | ON   | 2-3 5-6 8-9 | OFF  | (ON)      | 2-1 5-4 8-7 | 15A    | 6A                             | 15A | 8A  | 25° |                           |

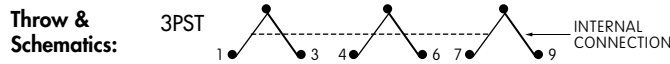

Note: Terminal numbers are on the switch

**Notes:** Standard Hardware: AT503M Face Hex Nut, AT506M Locking Ring, AT508 Lockwasher, AT527M Backup Hex Nut. See Accessories & Hardware section. Optional Splashproof Boot Assemblies: AT401 & AT4181 boots plus hex nut & o-ring. See Accessories & Hardware section.

\* Wire harness & cable assemblies offered only in Americas.

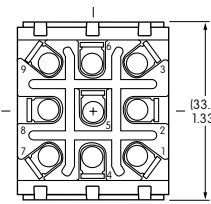
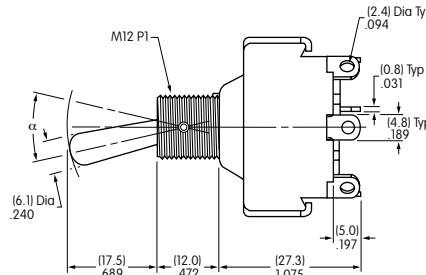
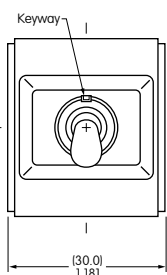

S31 does not have terminals 2, 5, & 8

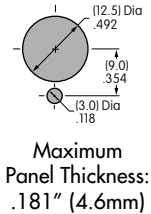

### FOUR POLE WITH SOLDER LUG \*

| Model<br>Suffix R = Flatted Lever | * Approvals |       |     | Pole & Throw | Toggle Position/Connected Terminals<br>( ) = Momentary |                   |      |           |                   |        | Electrical Capacity            |     |     |     | $\alpha$ = Angle of Throw |
|-----------------------------------|-------------|-------|-----|--------------|--|-------------------|------|-----------|-------------------|--------|--------------------------------|-----|-----|-----|---------------------------|
|                                   | UL          | cULus | CSA |              | Down<br>Keyway   | Center            | Up   | Resistive |                   |        | Inductive<br>AC 125V<br>PF 0.6 |     |     |     |                           |
|                                   |             |       |     |              |  |                   |      | AC 125V   | AC 250V           | DC 30V |                                |     |     |     |                           |
| S41/S41R                          | ✓           | ✓     | ✓   | 4PST         | ON   | 1-3 4-6 7-9 10-12 | NONE | OFF       | —                 | 25A    | 9A                             | 20A | 10A | 25° |                           |
| S42/S42R                          | ✓           | ✓     | ✓   | 4PDT         | ON   | 2-3 5-6 8-9 11-12 | NONE | ON        | 2-1 5-4 8-7 11-10 | 25A    | 9A                             | 20A | 10A | 25° |                           |
| S43/S43R                          | ✓           | ✓     | ✓   | 4PDT         | ON   | 2-3 5-6 8-9 11-12 | OFF  | ON        | 2-1 5-4 8-7 11-10 | 25A    | 9A                             | 20A | 10A | 30° |                           |
| S45                               | —           | ✓     | —   | 4PDT         | ON   | 2-3 5-6 8-9 11-12 | NONE | (ON)      | 2-1 5-4 8-7 11-10 | 15A    | 6A                             | 20A | 8A  | 25° |                           |
| S48/S48R                          | ✓           | ✓     | —   | 4PDT         | (ON)   | 2-3 5-6 8-9 11-12 | OFF  | (ON)      | 2-1 5-4 8-7 11-10 | 15A    | 6A                             | 20A | 8A  | 25° |                           |
| S49/S49R                          | ✓           | ✓     | —   | 4PDT         | ON   | 2-3 5-6 8-9 11-12 | OFF  | (ON)      | 2-1 5-4 8-7 11-10 | 15A    | 6A                             | 20A | 8A  | 25° |                           |

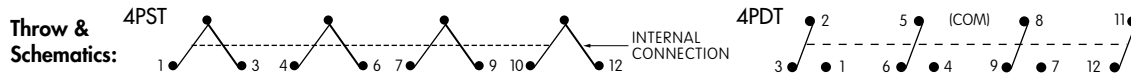

Note: Terminal numbers are on the switch

**Notes:** Standard Hardware for **Bat Lever**: AT503M Face Hex Nut, AT506M Locking Ring, AT508 Lockwasher, AT527M Backup Hex Nut; for **Flatted Lever (R)**: AT504M Knurled Face Nut, AT508 Lockwasher, AT527M Backup Hex Nut. See Accessories & Hardware section.

Optional Splashproof Boot Assemblies (only for bat lever models): AT401 & AT4181 boots plus hex nut and o-ring. See Accessories & Hardware section.

\* Wire harness & cable assemblies offered only in Americas.

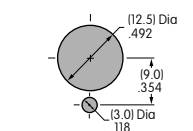
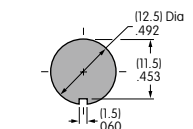
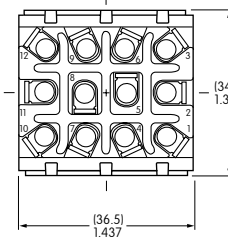
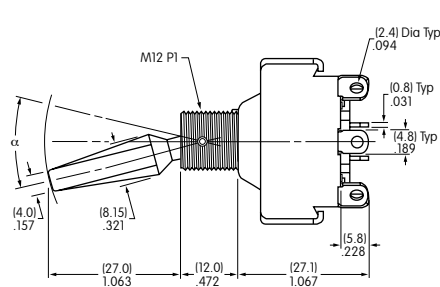
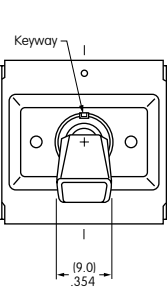

Bat lever dimensions are same as on S30 models above. S41 and S41R do not have terminals 2, 5, 8, & 11.

Rockers

Pushbuttons

Illuminated PB

Programmable

Keylocks

Rotaries

Slides

Tactiles

Tilt

Touch

Indicators

Accessories

Supplement

## THREE POLE WITH SCREW LUG

| * UL, cULus & CSA recognized only when ordered with marking on switch (see General Specs) |             |       | Toggle Position/Connected Terminals |              |   |   |   |           | Electrical Capacity |        |                |                |     | α = Angle of Throw |
|---|-------------|-------|-------------------------------------|--------------|---|---|---|-----------|---------------------|--------|----------------|----------------|-----|--------------------|
| Model   | * Approvals |       |                                     | Pole & Throw | Down<br> | Center<br> | Up<br> | Resistive |                     |        | Inductive      |                |     |                    |
|   | UL          | cULus | CSA                                 |              |   |   |   | AC 125V   | AC 250V             | DC 30V | AC 125V PF 0.6 | AC 250V PF 0.6 |     |                    |
| S31T  | ✓           | ✓     | ✓                                   | 3PST         | ON 1-3 4-6 7-9  | NONE  | OFF —   | 25A       | 9A                  | 20A    | 10A            | 5A             | 25° |                    |
| S32T  | ✓           | ✓     | ✓                                   | 3PDT         | ON 2-3 5-6 8-9  | NONE  | ON 2-1 5-4 8-7  | 25A       | 9A                  | 20A    | 10A            | 5A             | 25° |                    |
| S33T  | ✓           | ✓     | ✓                                   | 3PDT         | ON 2-3 5-6 8-9  | OFF   | ON 2-1 5-4 8-7  | 25A       | 9A                  | 20A    | 10A            | 5A             | 30° |                    |

**Throw & Schematics:**

3PST:  INTERNAL CONNECTION

3PDT:  (COM) 8

Note: Terminal numbers are on the switch

**Notes:** Standard Hardware: AT503M Face Hex Nut, AT506M Locking Ring, AT508 Lockwasher, AT527M Backup Hex Nut. See Accessories & Hardware section. Optional Splashproof Boot Assemblies: AT401 & AT4181 boots plus hex nut & o-ring. See Accessories & Hardware section.



## FOUR POLE WITH SCREW LUG

| * UL, cULus & CSA recognized only when ordered with marking on switch (see General Specs) |             |       | Toggle Position/Connected Terminals |              |   |   |   |           | Electrical Capacity |        |                |                |     | α = Angle of Throw |
|---|-------------|-------|-------------------------------------|--------------|---|---|---|-----------|---------------------|--------|----------------|----------------|-----|--------------------|
| Model   | * Approvals |       |                                     | Pole & Throw | Down<br> | Center<br> | Up<br> | Resistive |                     |        | Inductive      |                |     |                    |
|   | UL          | cULus | CSA                                 |              |   |   |   | AC 125V   | AC 250V             | DC 30V | AC 125V PF 0.6 | AC 250V PF 0.6 |     |                    |
| S41T  | ✓           | ✓     | ✓                                   | 4PST         | ON 1-3 4-6 7-9 10-12  | NONE  | OFF —   | 25A       | 9A                  | 20A    | 10A            | 5A             | 25° |                    |
| S42T  | ✓           | ✓     | ✓                                   | 4PDT         | ON 2-3 5-6 8-9 11-12  | NONE  | ON 2-1 5-4 8-7 11-10  | 25A       | 9A                  | 20A    | 10A            | 5A             | 25° |                    |
| S43T  | ✓           | ✓     | ✓                                   | 4PDT         | ON 2-3 5-6 8-9 11-12  | OFF   | ON 2-1 5-4 8-7 11-10  | 25A       | 9A                  | 20A    | 10A            | 5A             | 30° |                    |

**Throw & Schematics:**

4PST:  INTERNAL CONNECTION

4PDT:  (COM) 8

Note: Terminal numbers are on the switch

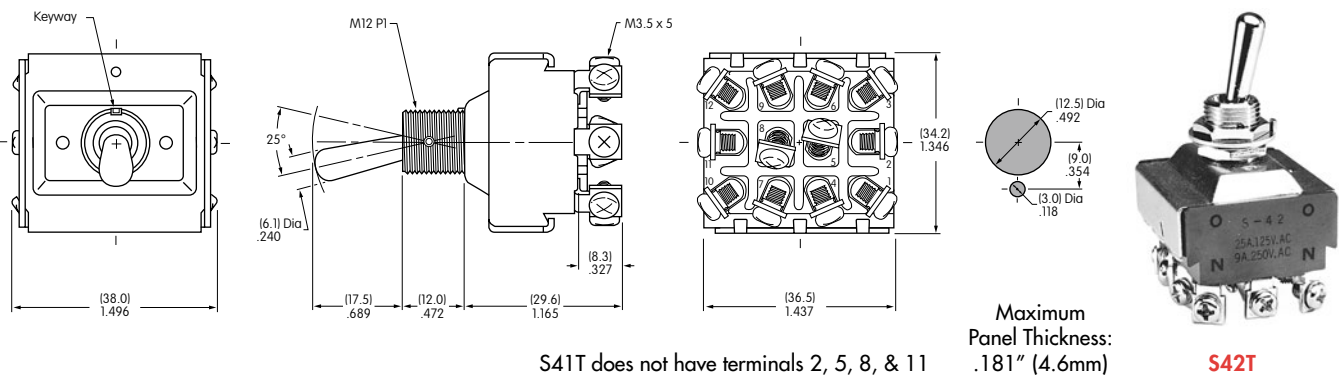

**Notes:** Standard Hardware: AT503M Face Hex Nut, AT506M Locking Ring, AT508 Lockwasher, AT527M Backup Hex Nut. See Accessories & Hardware section. Optional Splashproof Boot Assemblies: AT401 & AT4181 boots plus hex nut & o-ring. See Accessories & Hardware section.





Toggles  
A

### THREE POLE WITH QUICK CONNECT

| * UL, cULus & CSA recognized only when ordered with marking on switch (see General Specs) |             |       |     | Toggle Position/Connected Terminals |  |   |   |           | Electrical Capacity |        |                |                              |
|---|-------------|-------|-----|-------------------------------------|--|---|---|-----------|---------------------|--------|----------------|------------------------------|
| Model   | * Approvals |       |     | Pole & Throw                        | Down   | Center  | Up  | Resistive |                     |        | Inductive      | $\alpha =$<br>Angle of Throw |
|   | UL          | cULus | CSA |                                     | Keyway  |  |  | AC 125V   | AC 250V             | DC 30V | AC 125V PF 0.6 |                              |
| S31F  | ✓           | ✓     | ✓   | 3PST                                | ON 1-3 4-6 7-9   | NONE  | OFF   | 25A       | 9A                  | 20A    | 10A            | 25°                          |
| S32F  | ✓           | ✓     | ✓   | 3PDT                                | ON 2-3 5-6 8-9   | NONE  | ON 2-1 5-4 8-7  | 25A       | 9A                  | 20A    | 10A            | 25°                          |
| S33F  | ✓           | ✓     | ✓   | 3PDT                                | ON 2-3 5-6 8-9   | OFF   | ON 2-1 5-4 8-7  | 25A       | 9A                  | 20A    | 10A            | 30°                          |

Throw & Schematics:



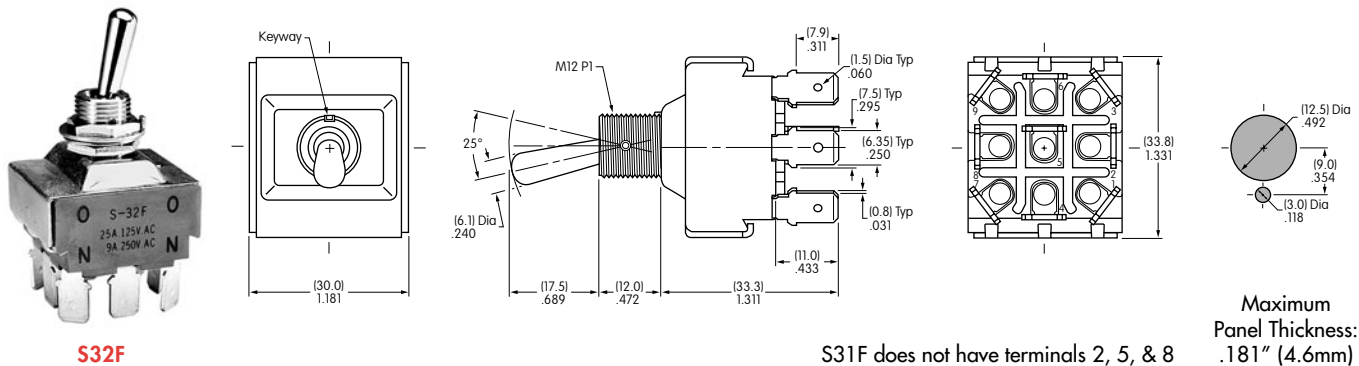

Note: Terminal numbers are on the switch

**Notes:** Standard Hardware: AT503M Face Hex Nut, AT506M Locking Ring, AT508 Lockwasher, AT527M Backup Hex Nut. See Accessories & Hardware section. Optional Splashproof Boot Assemblies: AT401 & AT4181 boots plus hex nut & o-ring. See Accessories & Hardware section.



### FOUR POLE WITH QUICK CONNECT

| * UL, cULus & CSA recognized only when ordered with marking on switch (see General Specs) |             |       |     | Toggle Position/Connected Terminals |  |   |  |           | Electrical Capacity |        |                |                              |
|---|-------------|-------|-----|-------------------------------------|--|---|--|-----------|---------------------|--------|----------------|------------------------------|
| Model   | * Approvals |       |     | Pole & Throw                        | Down   | Center  | Up   | Resistive |                     |        | Inductive      | $\alpha =$<br>Angle of Throw |
|   | UL          | cULus | CSA |                                     | Keyway  |  |  | AC 125V   | AC 250V             | DC 30V | AC 125V PF 0.6 |                              |
| S41F  | ✓           | ✓     | ✓   | 4PST                                | ON 1-3 4-6 7-9 10-12   | NONE  | OFF  | 25A       | 9A                  | 20A    | 10A            | 25°                          |
| S42F  | ✓           | ✓     | ✓   | 4PDT                                | ON 2-3 5-6 8-9 11-12   | NONE  | ON 2-1 5-4 8-7 11-10   | 25A       | 9A                  | 20A    | 10A            | 25°                          |
| S43F  | ✓           | ✓     | ✓   | 4PDT                                | ON 2-3 5-6 8-9 11-12   | OFF   | ON 2-1 5-4 8-7 11-10   | 25A       | 9A                  | 20A    | 10A            | 30°                          |

Throw & Schematics:



Note: Terminal numbers are on the switch

**Notes:** Standard Hardware: AT503M Face Hex Nut, AT506M Locking Ring, AT508 Lockwasher, AT527M Backup Hex Nut. See Accessories & Hardware section. Optional Splashproof Boot Assemblies: AT401 & AT4181 boots plus hex nut & o-ring. See Accessories & Hardware section.

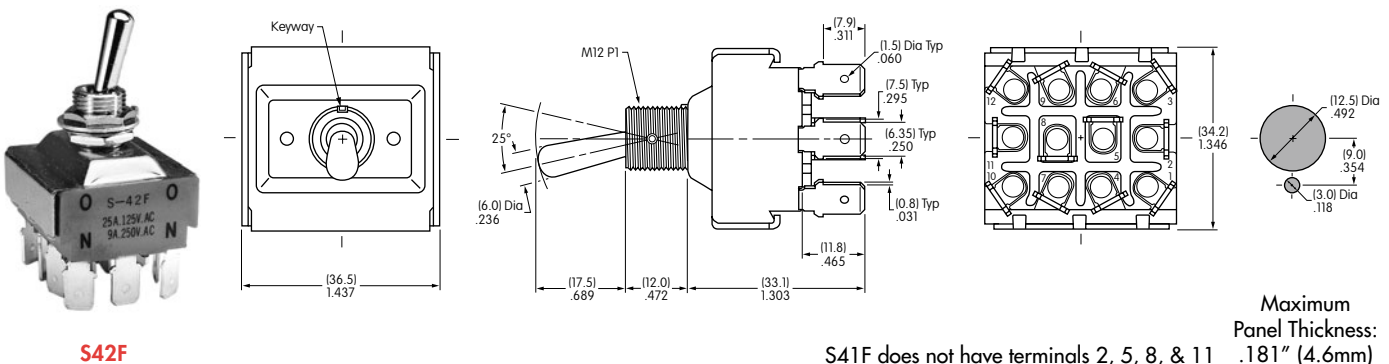

Rockers

Pushbuttons

Illuminated PB

Programmable

Keylocks

Rotaries

Slides

Tactiles

Tilt

Touch

Indicators

Accessories

Supplement

## GENERAL SPECIFICATIONS FOR S421 ~ S429

### Electrical Capacity (Resistive & Inductive Load)

**Power Level:** Shown in the following tables

### Other Ratings

**Contact Resistance:** 10 milliohms maximum  
**Insulation Resistance:** 1,000 megohms minimum @ 500V DC  
**Dielectric Strength:** 2,000V AC minimum for 1 minute minimum  
**Mechanical Life:** 50,000 operations minimum  
**Electrical Life:** 15,000 operations minimum  
**Angle of Throw ( $\alpha$ ):** Shown in tables on following pages

### Materials & Finishes

**Toggle:** Brass with chrome plating  
**Bushing:** Brass with chrome plating  
**Case:** Melamine phenol  
**Case Cover:** Steel with chromate plating over zinc plating  
**Movable Contactor:** Copper with silver plating  
**Movable Contacts:** Silver alloy capped on copper with silver plating  
**Stationary Contacts:** Silver alloy capped on copper with silver plating  
**Terminals:** Brass with tin plating

### Environmental Data

**Operating Temp Range:** -10°C through +70°C (+14°F through +158°F)

### Installation

**Mounting Torque:** 2.94Nm (26 lb·in) for double nut  
**Maximum Panel Thickness:** Shown beneath panel cutout in switch dimension drawings  
**Soldering Time & Temperature:** Manual Soldering: See Profile A in Supplement section.

A  
Toggles

Rockers

Pushbuttons

Illuminated PB

Programmable

Keylocks

Rotaries

Slides

Tactiles

Tilt

Touch



Indicators

Accessories

Supplement

Toggles  
A

### DOUBLE POLE WITH SOLDER LUG \*

| Model | Approvals |     | Pole & Throw | Toggle Position/Connected Terminals<br>( ) = Momentary                                    |   |   |           |         |               | Electrical Capacity |     |     |      | Motor Load<br>AC 125V | α = Angle of Throw |
|-------|-----------|-----|--------------|---|---|---|-----------|---------|---------------|---------------------|-----|-----|------|-----------------------|--------------------|
|       | UL        | CSA |              | Down<br> | Center<br> | Up<br> | Resistive |         | Inductive     |                     |     |     |      |                       |                    |
|       |           |     |              |   |   |   | AC 125V   | AC 250V | PF 0.75 - 0.8 |                     |     |     |      |                       |                    |
| S421  | —         | —   | DPST         | ON  | 1-3 4-6   | NONE  | OFF       | —       | 25A           | 25A                 | 25A | 25A | 750W | 24°                   |                    |
| S422  | —         | —   | DPDT         | ON  | 2-3 5-6   | NONE  | ON        | 2-1 5-4 | 25A           | 25A                 | 25A | 25A | 750W | 24°                   |                    |
| S423  | —         | —   | DPDT         | ON  | 2-3 5-6   | OFF   | ON        | 2-1 5-4 | 25A           | 25A                 | 25A | 25A | 750W | 28°                   |                    |
| S425  | —         | —   | DPDT         | ON  | 2-3 5-6   | NONE  | (ON)      | 2-1 5-4 | 15A           | 15A                 | 15A | 15A | 400W | 24°                   |                    |
| S428  | —         | —   | DPDT         | (ON)  | 2-3 5-6   | OFF   | (ON)      | 2-1 5-4 | 15A           | 15A                 | 15A | 15A | 400W | 24°                   |                    |
| S429  | —         | —   | DPDT         | ON  | 2-3 5-6   | OFF   | (ON)      | 2-1 5-4 | 15A           | 15A                 | 15A | 15A | 400W | 24°                   |                    |

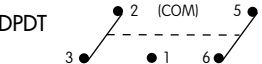
**Throw & Schematics:** DPST  INTERNAL CONNECTION  Note: Terminal numbers are on the switch

**Notes:** Standard Hardware: AT503M Face Hex Nut, AT506M Locking Ring, AT508 Lockwasher, AT527M Backup Hex Nut. See Accessories & Hardware section.  
Optional Splashproof Boot Assemblies: AT401 & AT4181 boots plus hex nut & o-ring. See Accessories & Hardware section.

\* Wire harness & cable assemblies offered only in Americas.

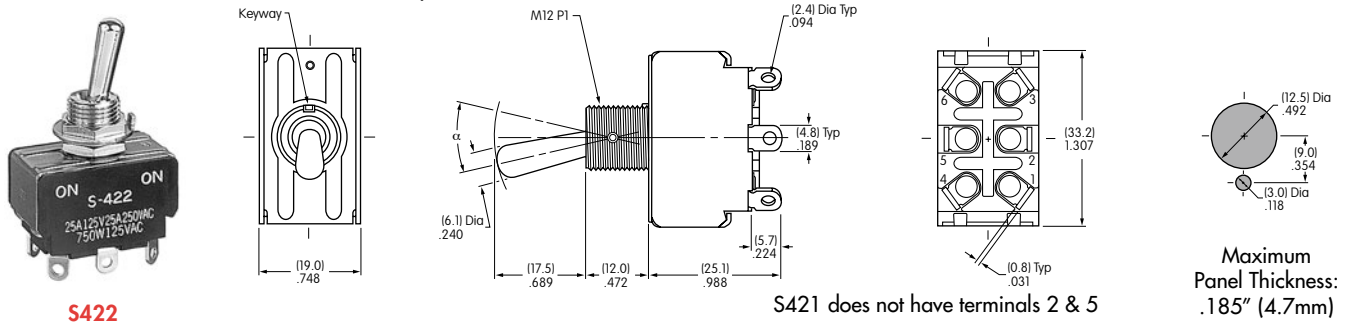



S422

S421 does not have terminals 2 & 5

Maximum Panel Thickness: .185" (4.7mm)

### DOUBLE POLE WITH SCREW LUG

| Model | Approvals |     | Pole & Throw | Toggle Position/Connected Terminals<br>( ) = Momentary                                      |   |   |           |         |               | Electrical Capacity |     |     |      | Motor Load<br>AC 125V | α = Angle of Throw |
|-------|-----------|-----|--------------|---|---|---|-----------|---------|---------------|---------------------|-----|-----|------|-----------------------|--------------------|
|       | UL        | CSA |              | Down<br> | Center<br> | Up<br> | Resistive |         | Inductive     |                     |     |     |      |                       |                    |
|       |           |     |              |   |   |   | AC 125V   | AC 250V | PF 0.75 - 0.8 |                     |     |     |      |                       |                    |
| S421T | —         | —   | DPST         | ON  | 1-3 4-6   | NONE  | OFF       | —       | 20A           | 20A                 | 20A | 20A | 750W | 24°                   |                    |
| S422T | —         | —   | DPDT         | ON  | 2-3 5-6   | NONE  | ON        | 2-1 5-4 | 20A           | 20A                 | 20A | 20A | 750W | 24°                   |                    |
| S423T | —         | —   | DPDT         | ON  | 2-3 5-6   | OFF   | ON        | 2-1 5-4 | 20A           | 20A                 | 20A | 20A | 750W | 28°                   |                    |
| S425T | —         | —   | DPDT         | ON  | 2-3 5-6   | NONE  | (ON)      | 2-1 5-4 | 15A           | 15A                 | 15A | 15A | 400W | 24°                   |                    |
| S428T | —         | —   | DPDT         | (ON)  | 2-3 5-6   | OFF   | (ON)      | 2-1 5-4 | 15A           | 15A                 | 15A | 15A | 400W | 24°                   |                    |
| S429T | —         | —   | DPDT         | ON  | 2-3 5-6   | OFF   | (ON)      | 2-1 5-4 | 15A           | 15A                 | 15A | 15A | 400W | 24°                   |                    |

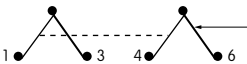
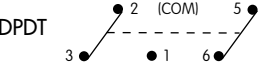
**Throw & Schematics:** DPST  INTERNAL CONNECTION  Note: Terminal numbers are on the switch

**Notes:** Standard Hardware: AT503M Face Hex Nut, AT506M Locking Ring, AT508 Lockwasher, AT527M Backup Hex Nut. See Accessories & Hardware section.  
Optional Splashproof Boot Assemblies: AT401 & AT4181 boots plus hex nut & o-ring. See Accessories & Hardware section.

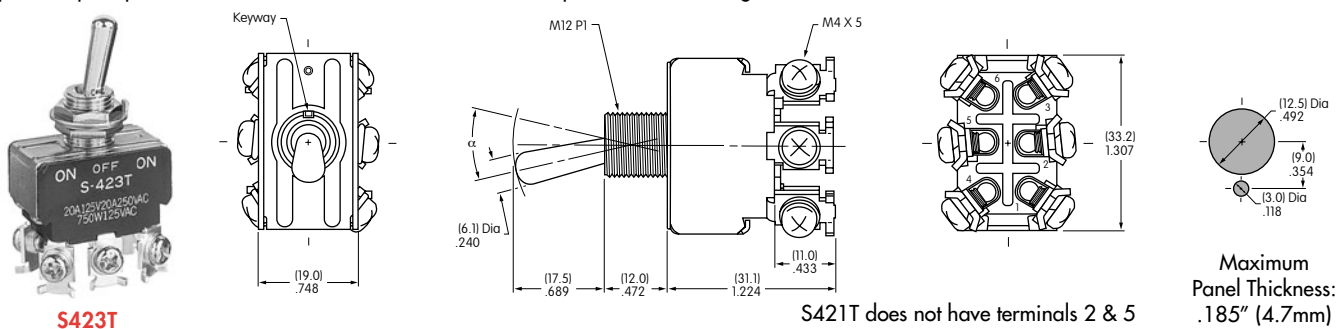

S423T

S421T does not have terminals 2 & 5

Maximum Panel Thickness: .185" (4.7mm)

Rockers

Pushbuttons

Illuminated PB

Programmable

Keylocks

Rotaries

Slides

Tactiles

Tilt

Touch

Indicators

Accessories

Supplement